

Article number: 208050371

Description: E+G Sphericalwasher male DIN 6319-43-C-NI
Stainless Steel 1.4305

Measures

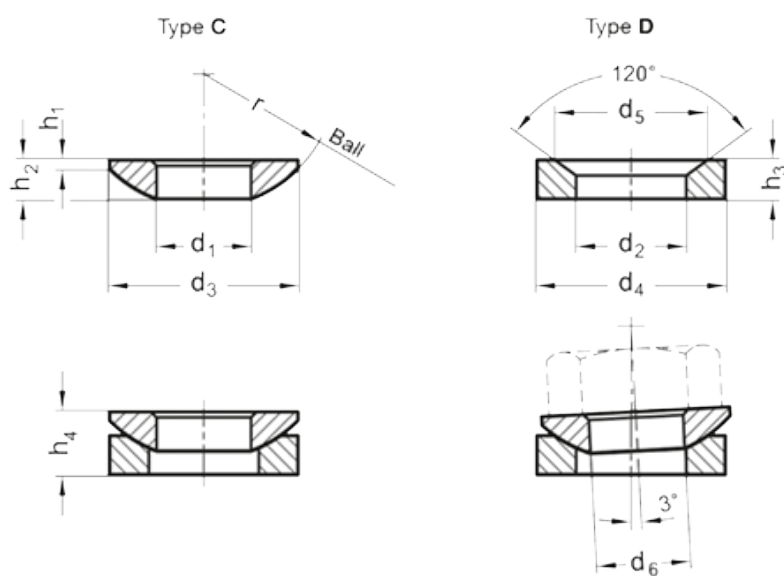

$d_1 = 43.0$

$d_3 = 78$

$d_6 = M42$

$H_1 = 6.5$

$H_2 = 17.0$

$H_4 = 29.0$

$r = 58$